



MODEL: PJ-075DH-SMT-TR | **DESCRIPTION:** DC POWER JACK

FEATURES

- 1.3 mm center pin
- 3.5 A rating
- low profile
- surface mount (SMT)
- internal switch



SPECIFICATIONS

parameter	conditions/description	min	typ	max	units
rated input voltage			24		Vdc
rated input current				3.5	A
contact resistance ¹	between terminal and mating plug between terminal in a closed circuit			50 30	mΩ mΩ
insulation resistance	at 500 Vdc	100			MΩ
voltage withstand	for 1 minute			500	Vac
insertion/withdrawal force		0.3		3	kg
operating temperature		-25		85	°C
life	at a rate of 24 cycles/minute		5,000		cycles
flammability rating	UL94V-0				
RoHS	2011/65/EU				

Note: 1. When measured at a current of less than 100 mA/1 kHz
 2. All specifications measured at 10~35°C, humidity at 45~85%, under standard atmospheric pressure, unless otherwise noted.

SOLDERABILITY

parameter	conditions/description	min	typ	max	units
reel storage	at relative humidity <80%			40	°C
reflow soldering ³	see reflow profile	255	260	265	°C
drying conditions ⁴	parts in reel: bake at 40°C ±5°C for 72 hours parts removed from reel: bake at 40°C ±5°C for 10 hours				

Note: 3. Must reflow solder within 72 hours from opening vacuum packaging at a temperature <30°C & relative humidity <60%.
 4. When exceeding floor life by >72 hours.



MECHANICAL DRAWING

units: mm[inches]
 tolerance:
 X.X ±0.2mm
 X.XX ±0.1mm
 X.XXX ±0.05mm

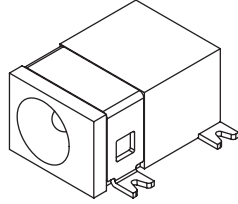

	MATERIAL	PLATING
center pin	copper	nickel
terminal 1	brass	silver
terminal 2	copper alloy	silver
terminal 3	brass	silver
shield	brass	silver
plastic	PA6T or equivalent	

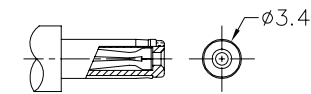
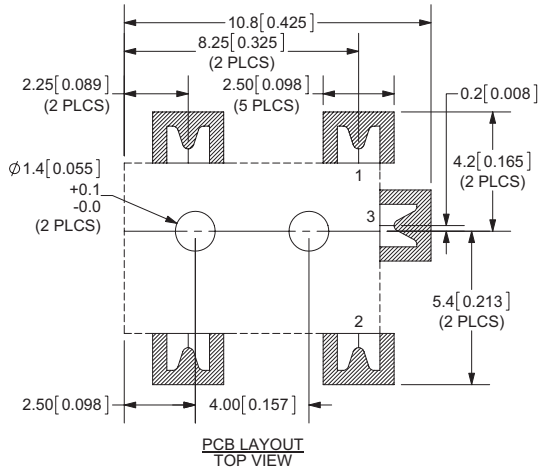
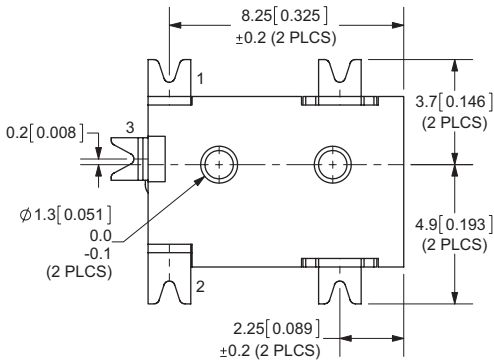
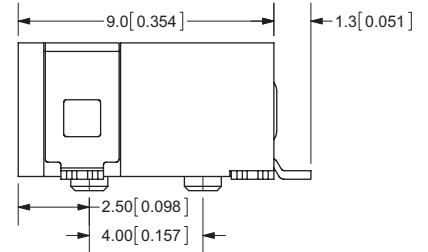
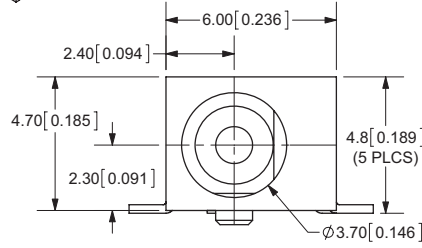
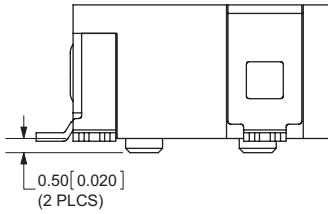

MATING PLUG
 Jack Insertion Depth: 6.4mm

SCHEMATIC	
Model	PJ-075DH-SMT
Center Pin	Ø1.3 mm

PACKAGING

units: mm

Reel Size: $\varnothing 381$ mm

Reel QTY: 950 pcs per reel

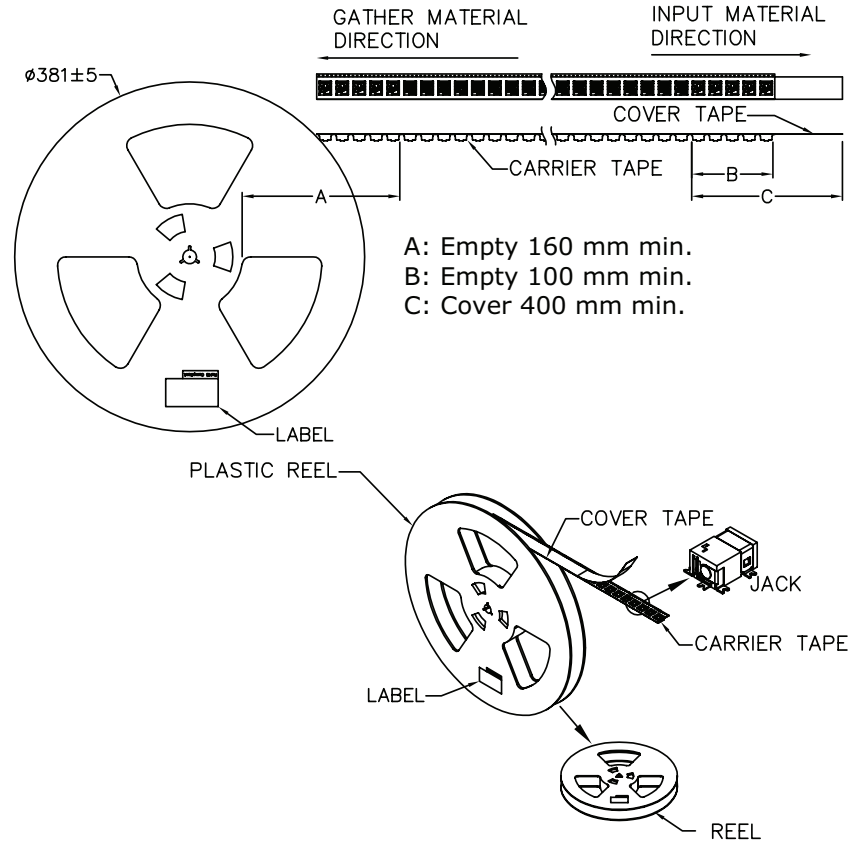
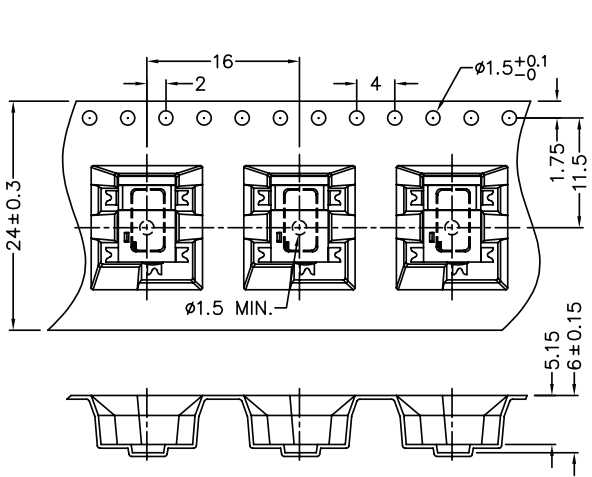

REVISION HISTORY

rev.	description	date
1.0	initial release	03/16/2012
1.01	increased voltage rating	05/17/2016
1.02	added storage and drying conditions, and tape and reel packaging details	07/24/2017

The revision history provided is for informational purposes only and is believed to be accurate.



Headquarters
20050 SW 112th Ave.
Tualatin, OR 97062
800.275.4899

Fax 503.612.2383
cui.com
techsupport@cui.com

CUI offers a one (1) year limited warranty. Complete warranty information is listed on our website.

CUI reserves the right to make changes to the product at any time without notice. Information provided by CUI is believed to be accurate and reliable. However, no responsibility is assumed by CUI for its use, nor for any infringements of patents or other rights of third parties which may result from its use.

CUI products are not authorized or warranted for use as critical components in equipment that requires an extremely high level of reliability. A critical component is any component of a life support device or system whose failure to perform can be reasonably expected to cause the failure of the life support device or system, or to affect its safety or effectiveness.